

soon

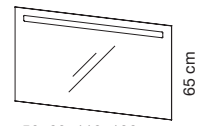

MIROIRS - SPIEGEL



50, 80, 110, 130 cm

Eclairage LED - LED Beleuchtung

ARMOIRETTE OBERSCHRANK

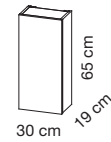

ARMOIRES - SPIEGELSCHRANK

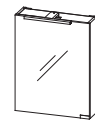

50 cm

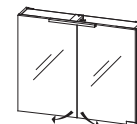

80 cm

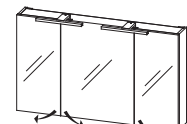

110, 130 cm

Eclairage LED - LED Beleuchtung

TABLES - WASCHTISCH



50 cm
gauche ou droite
links oder rechts



80 cm
gauche ou droite
links oder rechts

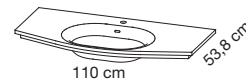

110 cm

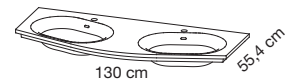

130 cm

MEUBLES - UNTERSCHRANK



50 cm
gauche ou droite
links oder rechts

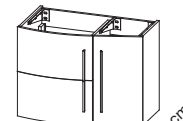

80 cm
gauche ou droite
links oder rechts

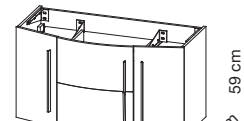

110, 130 cm

59 cm
52,8 cm

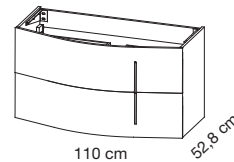

110 cm

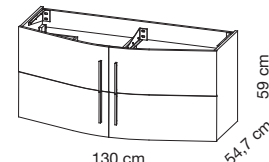

130 cm

59 cm
54,7 cm

COLONNES HOCHSCHRANK

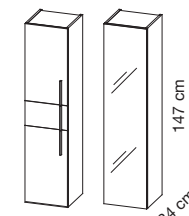

35 cm

35 cm

147 cm
34 cm

Gauche ou droite
links oder rechts

COMMODE KOMMODE

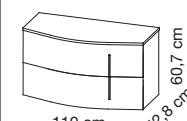

110 cm

60,7 cm
52,8 cm

CRÉDENCES HINTERWAND

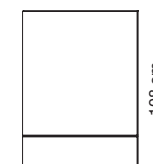

108 cm

50, 80, 110, 130 cm

ACCESSOIRES

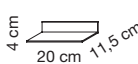

4 cm

20 cm

11,5 cm



6 cm

9 cm

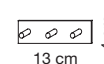

13 cm

4 cm



10 cm

12 cm



12 cm

soon

Prévoir sortie de fils à 1,62 m du sol pour les miroirs et 1,85 m pour les armoires. Vide sanitaire : 5,5 cm.
 Kabelpositionierung für Anschluss 1,62 m für Spiegel und 1,85 m für Spiegelschrank. Hohlraum 5,5 cm.

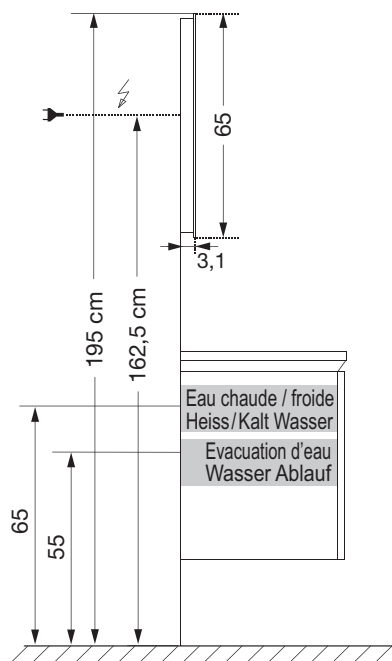

Meuble + miroir
Unterschrank + Spiegel

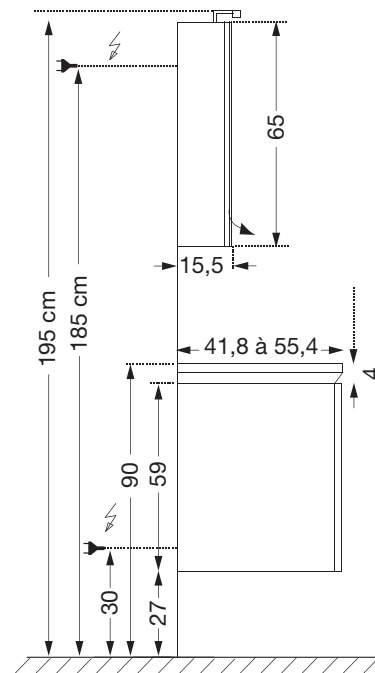

Meuble + armoire
Unterschrank + Spiegelschrank

COLORIS - FARBEN:

- TABLES marbre de synthèse blanc brillant - WASCHTISCH Mineralmarmor
- INTÉRIEUR basalte - INNEN Dekor basalte
- MEUBLES (côtés et façades) - UNTERSCHRANK (Seiten, Fronten):

Meuble - Unterschrank	Meuble, Crédence - Unterschrank, Hinterwand
LAQUES SATINÉES ou BRILLANTES ou SOFT LACK SEIDENMATT oder HOCHGLANZ oder SOFT	MÉLAMINÉ BOIS (veinage horizontal) DEKOR (Maserung waagerecht)
aigue marine, amande, ardoise, argile, aubergine, beige, blanc, bleu orage, capucine, coquelicot, framboise, fushia, galaxy, gris anthracite, gris souris, gris titane, jasmin, jaune, lagune, magma, marron glacé, menthol, noir, nude, olivier, rose pâle, rose poivré, taupe.	chêne Arlington, chêne gris, noyer clair. blanc brillant (cédence uniquement). Dekor blanc brillant (nur für Hinterwand).

MY COLOR : SURCÔÛT 300 CHF PAR RÉFÉRENCE / PAR COULEUR (voir page 9)
MY COLOR: AUFPREIS 300 CHF PRO REFERENZ / PRO FARBE (Seite 9)

DÉTAIL VASQUE - WASCHTISCH

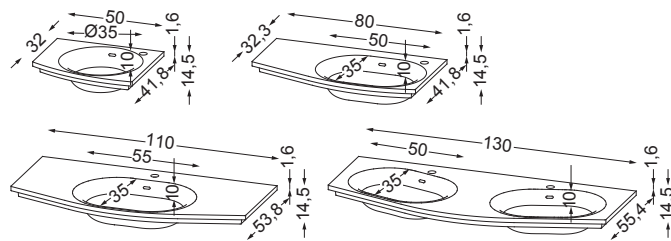

DÉTAIL MEUBLE - UNTERSCHRANK

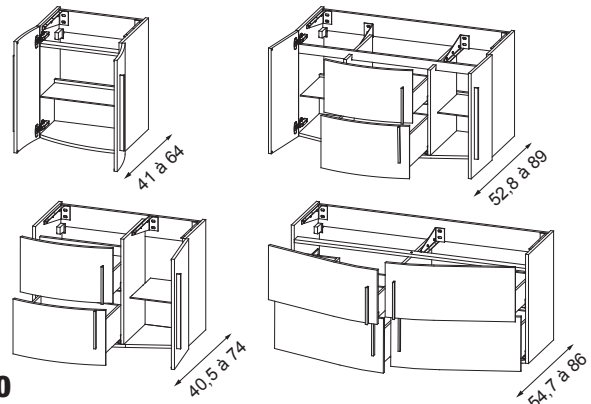

INFORMATION :

- Les meubles sont livrés sans visserie de fixation.
- Les rubans LED sont à coller sous le plan de toilette.

NOUVEAU ! Poignée aluminium brossé ou chromé brillant.
Penser à préciser à la commande.

- Lors de l'installation d'un plan vasque 50 cm avec crédence, privilégier un robinet «mélangeur» ou s'assurer que le mitigeur choisi soit compatible (espace restreint entre la crédence et l'axe de la robinetterie limitant les modèles compatibles).

INFO

- Die Möbel werden ohne Befestigungsschrauben geliefert.
- Das Led-Band wird unter dem Waschtisch angeklebt

NEU! Griff Aluminium matt oder verchromt glänzend.

- Für Waschtisch breite 50 cm mit Hinterwand Mischarmatur einsetzen (Achtung : beschränkter Platz für Armatur).